



Venture IP Telephone System

USER GUIDE



Table of Contents

Introduction	1	Making and Receiving Calls.....	18
About this Guide	1	Handsfree Calling.....	18
Requirements.....	1	Make Calls Using a Stored	
Phone Parts	1	Number List.....	18
Installation	2	Redialing a Recently Called	
Overview	2	Number	18
Direct Network Connection	3	Making a Call Using an	
Connect to the Network and to a		Incoming Call, Directory, or	
Power Source	3	Speed Dial List	19
Connecting When Inline Power is		Receive Calls	19
Provided	3	Receiving A Call.....	19
Connecting When Inline Power is		Receiving Multiple Calls.....	19
Not Provided	4	Call Duration	20
Connecting the Handset	4	End a Call.....	20
Shared Network Connection	5	Call Handling	21
Installing on a Desk	5	Hold.....	21
Inserting the Number Card	6	Conference Calls.....	21
Getting to Know Your VentureIP		Adding Parties to a	
480i Telephone	7	Conference Call	21
Key Description.....	7-8	Putting Conference Callers On	
Set Overview	9	Hold and Off Hold	22
Display Screen	9	Dropping Parties from a	
Softkeys	9	Conference Call.....	22
Navigating.....	9	Mute	22
Editing text	10	Transfer.....	23
Entering Letters and		Transferring a Call	23
Characters	10	Call Forwarding	24
Display Icons	11	Options for Forwarding Calls....	24
Status Lights	11	Using Voicemail	25
Handset, Headset, and		View, Play, and Monitor Incoming	
Handsfree Operation.....	12	Voicemail Messages	25
User Options	12	Logging In and Viewing	
Services	13	Messages	26
Administrating Services.....	14	Playing a Message	26
Stored Number Lists	14	Monitoring Incoming Voicemail	
Changing Your Personal		Message	26
Information	15	Manage Voicemail Messages ..	26
Changing Your Last Name.....	15	Copying the Caller Information to your	
Passwords	15	Directory or Speed Dial List	27
Changing Your Password.....	15	Zero Redirect	27
Enabling and Disabling Your		Language Selection	27
Password	15	Change Voicemail Options	28
Customizing Your Phone.....	16	Recording Your Name and	
Language Selection	16	Greeting	28
Adjusting the Volume	16	Retrieving Voicemail.....	28
Select Audio Path	16	Message Review Options.....	28
Self Test and Diagnostics	17	Callers	29

Table of Contents

Using Directories	30
About Directory Lists	30
Access and View a Directory List	30
Accessing a Directory List and Viewing the Entries	30
Change Directory Displays	30
Add, Delete, and Edit Entries ...	31
Adding an Entry From the Caller List or a Voicemail Message.....	31
Using a Call List.....	32
About Call Lists	32
Access and View a Call List	32
Edit Entries.....	32
Temporarily Editing a Call List.....	32
Add a Call List Entry to a Personal Directory or Speed Dial List	33
Copying an Entry from a Call List ..	33
Delete Call List Entries	33
Using Speed Dial.....	34
About Speed Dial	34
Access and View the Speed Dial List	34
Special Features	36
Do Not Disturb.....	36
Enabling and Disabling the Do Not Disturb Feature.....	36
Intercom	36
Computer Access to Telephone Features.....	36
Troubleshooting	38
Limited Warranty	40

Introduction

About this Guide

This user guide provides basic installation instructions and describes all user-enabled features for the VentureIP 480i telephone. The **VentureIP 480i System Guide** offers more detailed technical instructions regarding network installation, configuration, downloads and set management. The **VentureIP Gateway Installation Guide** specifically addresses the installation and technical specifications of the VentureIP Gateway.

Requirements

You require the following to install your VentureIP 480i Telephone:

- 802.3 Ethernet/Fast Ethernet LAN (please note that this document does not provide any instructions regarding the installation of a LAN or router).
- Category 5/5e straight through cabling
- A PoE (Power over Ethernet) inline power supply, necessary only if your network does not provide 802.3af compliant in-line power (optional accessory)

Phone Parts

When you unpack your phone, ensure that you have all of the following items. If any part is missing, contact your supplier.

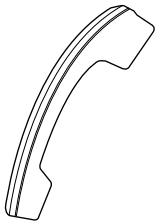

handset

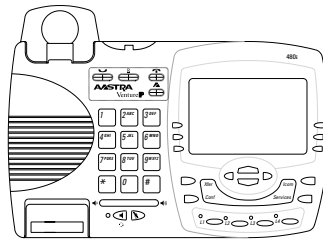

telephone



handset cord

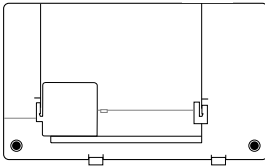

number card
and lens

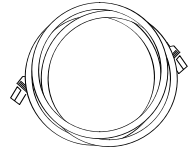

Ethernet Cable

Optional Accessories (Not Included)

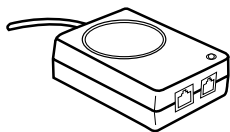

PoE (Power over Ethernet) Inline Power Supply

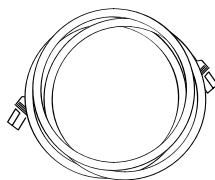

Additional Ethernet Cable (category 5/5e straight through cable)

A PoE (Power over Ethernet) inline power adapter supplies 48v power to the 480i through the Ethernet Cable on pins 1 & 2 and 3 & 6. Do not use this power supply to power other devices.

- **Voltage:** 110/120 V AC in; 48 V DC out

Safety and emissions: Canada: ICES-003 Class A; Japan: VCCI Class A; U.S.: FCC Class A, CSA, C-Tick, NOM

Installation

Overview

The VentureIP 480i Telephone can be set up to share a network connection with another network device. Power can be provided by an 802.3af compliant network power source, or a PoE inline power supply (optional accessory).

The phone can be set up either:

- with a direct network connection to the Ethernet wall jack, or
- as a shared network connection with pass-through if connecting the phone to a computer or other network device.

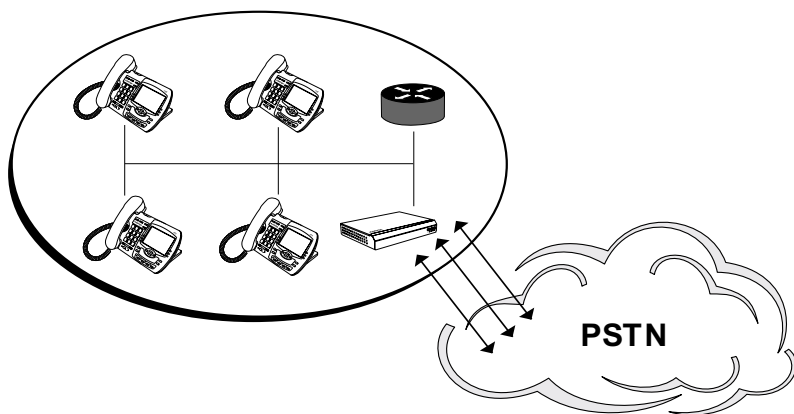

Direct Network Connection

Located at the back of the phone are two fully switched 10/100 Mbps Ethernet cable ports. Use the port marked with  to connect the phone to the network, and to provide power to your phone. See “**Connect to the Network and to a Power Source**” for more information.

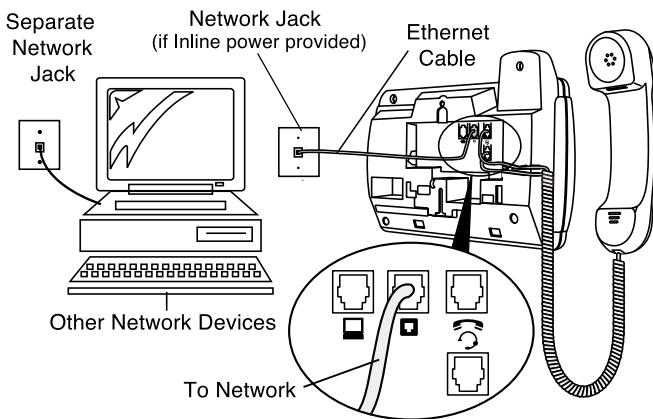

Connect to the Network and to a Power Source

If your network provides 802.3af compliant in-line power, the phone will be provided with power through the network.

If your network does not provide 802.3af compliant in-line power, you will need to install the PoE inline power supply (optional accessory).

Connecting When Inline Power is Provided

1. On the back of your phone, connect the Ethernet cable (provided with your phone) into the network port marked with .
2. Plug the other end of the Ethernet cable into the network jack on the wall.

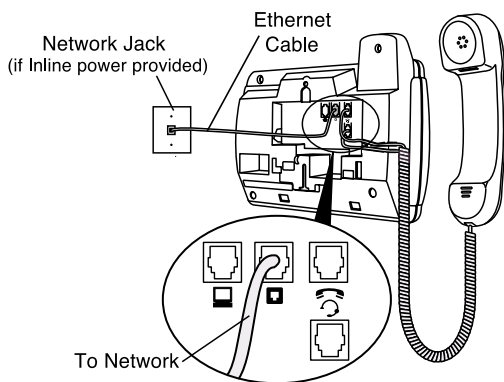

Connecting When Inline Power is Not Provided

1. On the back of your phone, connect the Ethernet cable (provided with your phone) into the network port marked with .
2. On the PoE power supply, plug the other end of the Ethernet cable into the network jack marked as shown in the following diagram.
3. On the PoE power supply, connect an additional Ethernet cable into the network port as shown in the following diagram.
4. Plug the other end of the Ethernet cable into the network jack on the wall.
5. Plug the PoE power supply into a power outlet. You should connect the power supply to a surge protector or power bar.

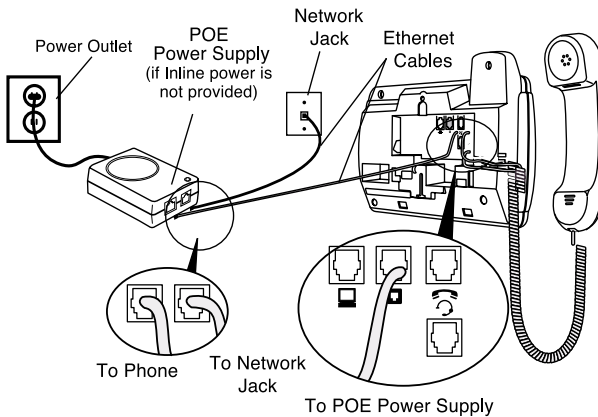

Note: All Ethernet cables must be category 5/5e straight-through cables, such as the cable provided with your phone.

Connecting the Handset

1. Turn the phone over and locate the handset jack marked .
2. Insert one end of handset cord into the jack until it clicks into place.
3. Route the handset cord through the upper groove as shown in the diagram below.
4. Attach the handset to the other end of the handset cord.

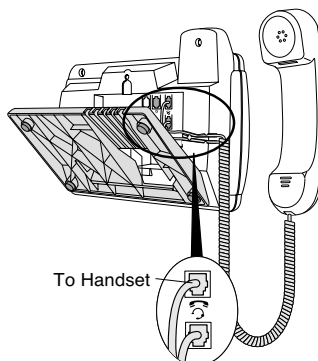

Shared Network Connection

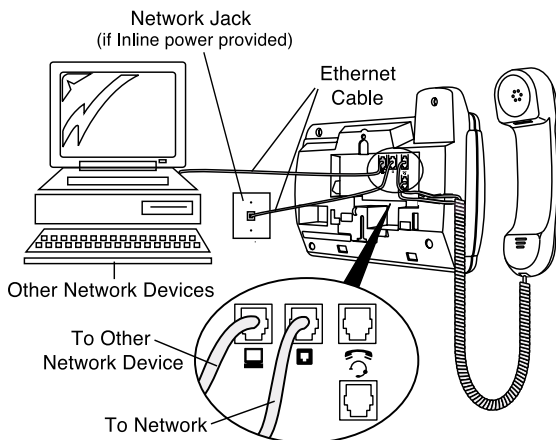

To connect a network device (such as a computer) to the phone, connect an Ethernet Cable into the network port on the back of the phone marked with . Plug the other end of the Ethernet Cable into the network jack on the network device that you are sharing the network connection with.

Note: The  jack on the 480IP does not supply inline power onto other network devices.



Note: All Ethernet cables must be category 5/5e straight-through cables, such as the cable provided with your phone.

Installing on a Desk

1. Route the cables through the opening in the stand.
2. Attach the stand by inserting the tabs on the stand (marked with ) into the slots on the bottom of the phone. For a higher viewing angle, use the slots marked . For a lower viewing angle, use the slots marked .
3. Push the stand towards the phone until it snaps into place.
4. Press the cords into the grooves provided on the bottom of the stand. This will allow the stand to sit flat on a desk surface.

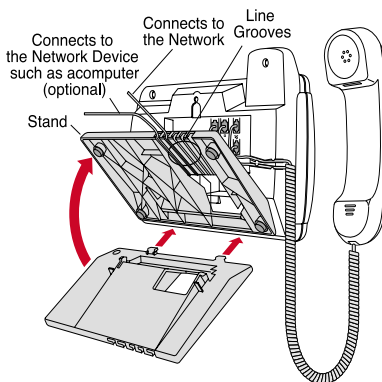

Inserting the Number Card

1. Write your phone number on the number card, and place it into the card slot on the phone, located under the mouthpiece in the handset cradle.
2. Gently bend the clear plastic lens into the slot, over the number card.

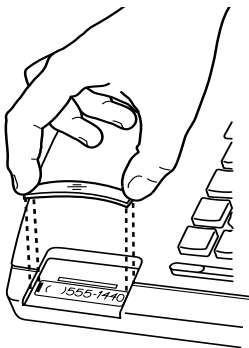

Getting to Know Your VentureIP 480i Telephone



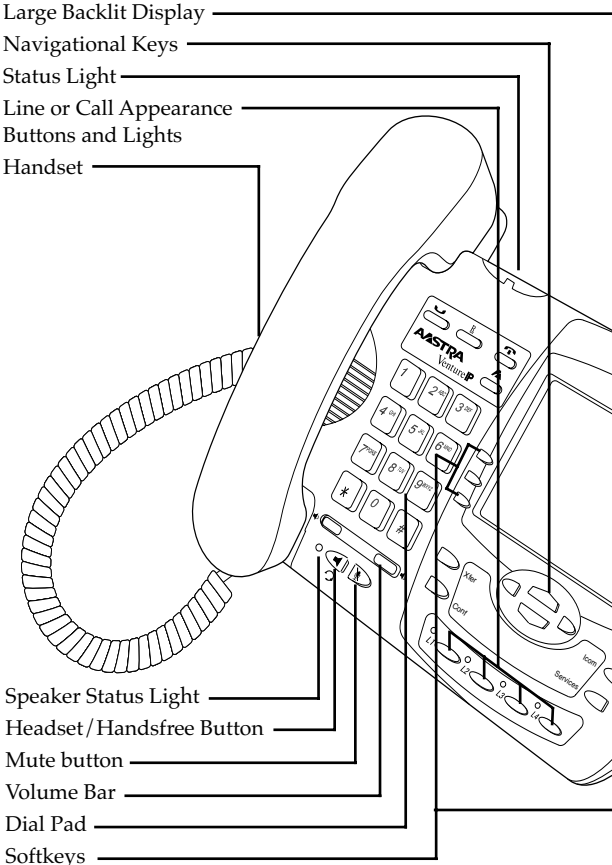



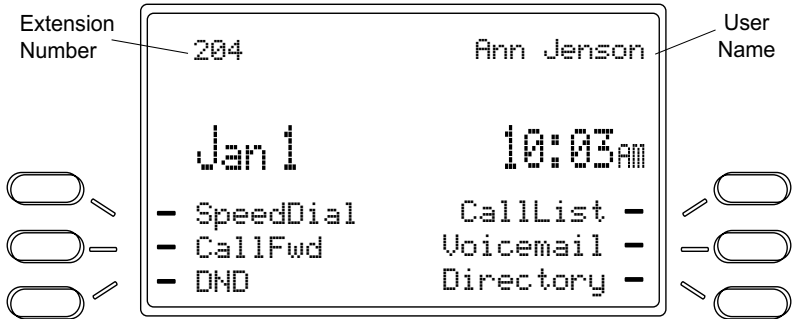



Key Description



Display Screen

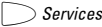
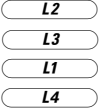

Key Description

Keys	Key Description
	Places an active call on hold. For more information, see “ Hold ”.
	Redials previously dialed numbers. For more information, see “ Redialing a Recently Called Number ”.
	Ends an active call, or exits an open list (for example, a directory list), without saving changes.
	Accesses options for administering services and customizing your phone. For more information, see “ Change Voicemail Options ”, “ Changing Your Personal Information ”, or “ Customizing Your Phone ”.
	Adjusts the volume for the handset, ringer, or handsfree speaker. For more information, see “ Customizing Your Phone ”.
	Activates handsfree phone operation.
	Prevents a caller from hearing you through the handset or handsfree microphone. For more information, see “ Call Handling ”.
 <i>Xfer</i>	Transfers the active call to another number. For more information, “ Call Handling ”.
 <i>Conf</i>	Begins a conference call with an active call. For more information, see “ Call Handling ”.
	Navigates between display screens, onscreen text, and menu selections. For more information, see “ Display Screen ”.
 <i>Icom</i>	Accesses the Intercom feature. For more information, see “ Special Features ”.
 <i>Services</i>	Accesses the available features on your phone. For more information, see “ Services ”.
	Connects you to a line or an incoming call. For more information, see “ Making Calls ” and “ Receiving Calls ”.

Set Overview

Display Screen

The display screen provides an interactive interface that shows information about calls and features.

The upper portion of the screen displays information, and the lower portion displays options that correspond to six “softkeys” on either side of the screen.

The contents of the display screen change, depending on the status of the phone (such as any active calls in progress, or any features in use).

Softkeys

There are six softkeys on either side of the lower portion of the display screen. The functions of the softkeys change, depending on the current status of the phone. For example, if you are customizing your phone, the softkeys will reflect the customization options available to you. If you are listening to a voicemail message, the softkeys will reflect the options available to you for processing that voicemail message. The softkey label is displayed directly beside the softkey, and indicates the current function of that softkey.





Navigating

You use the display screen to perform many functions on the phone.

Use the softkeys to navigate into and out of a display screen, as follows:

Softkey	Key Description
Exit	leave the currently displayed feature or list.
Back	move back one level in a menu hierarchy.
Cancel	cancel the current process. No changes are saved.
Select	select the current list item.
Done	end the current process and save any changes.
Next	go to the next step in a multi-step process.

Use the navigation keys (located beneath the display screen) to navigate, as follows:

Navigation Key	Key Description
	move to the next screen or list item.
	move to the previous screen or list item.
	move back one level in a menu hierarchy.
	select the current list item.

Editing text

When you need to edit onscreen display text, (for example, to enter a directory list name), use the following guidelines:

To	Do this
enter text at the current cursor position.	Press the dialpad key with the corresponding letter on it. Press once for the first letter, twice for the second, and three times for the third. For example, to type "R", press the dialpad key three times.
move the cursor to the left without deleting.	Press the ◀ key.
move the cursor to the right without deleting.	Press the ▶ key.
add a space at the end of a line.	Press the ▶ key.
move the cursor to the left and delete.	Press the backspace softkey.
change the case of a character.	Press the ChangeCase softkey. Note: The first character in a line, and the first character after a space are automatically capitalized.

Entering Letters and Characters





You can enter characters using the telephone's dial pad. To enter a letter, press the key with that letter on it. If the letter is the second one on that key, press the key twice. For example, to enter 'R', press 7 three times. The cursor will advance to the next space after a delay of 2 seconds or if you press a different key.

To change the case of a letter, press the **ChangeCase** softkey, and then enter the letter. By default the first letter of a word or name will be capitalized, and the letters following will be lower case.

Special characters are entered by pressing the 1 and the # keys. Characters will appear in this order:



1: *, () ` . - 1. #: # / \ @.

Display Icons

Icon	Description
	Use the up and down navigation keys to view more information. When shown beside the first or last item in a list, indicates that there are additional list items not shown on the screen. Use the navigation keys to scroll through all list items.
	Use the left and right navigation keys to view more information.
	The call associated with this Incoming Call List entry was not answered.
	The call associated with this Incoming Call List entry was answered.
	You have returned the missed call associated with this Incoming Call List entry.

Status Lights

There are three sets of status lights:

- Status Light – located above the **R** key
- speaker light – located beside the  /  key
- call appearance lights – located beside each  key

Light	Status	Indicates
Status Light	fast blink	incoming call
	slow blink	message waiting
Speaker Light	solid	solidphone is in handsfree operation
	blink	microphone is muted in Handsfree mode
Call Appearance Lights	solid	an active call is on the line
	slow blink	a held call is on the line
	fast blink	incoming call is on the line

Handset, Headset, and Handsfree Operation

You can use your phone in handset, headset, or handsfree operation. Handset is the default operation. To switch to headset operation, plug in the headset. To switch to handsfree operation, use the ◀/▶ key.

User Options

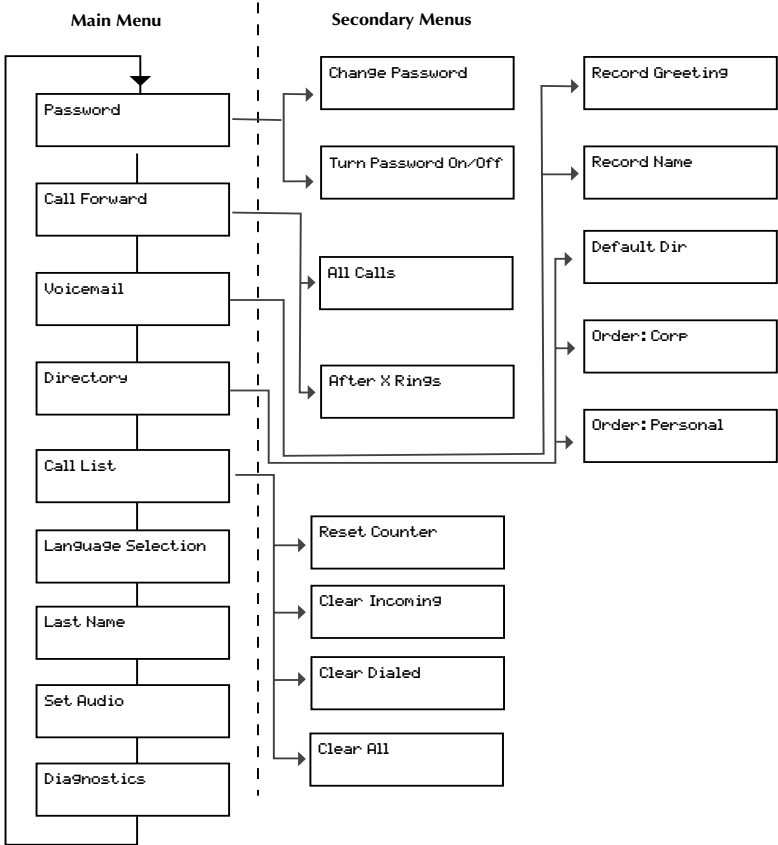

User Options Menu

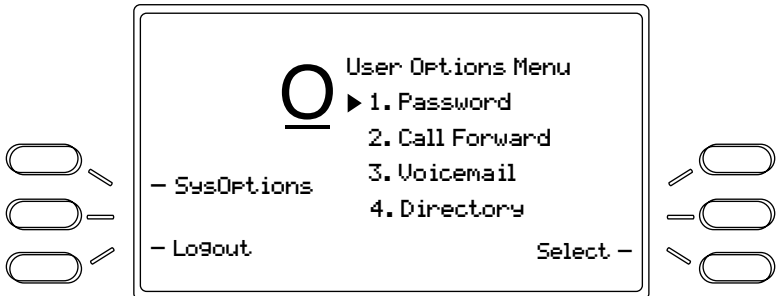

Services

Menu

- Speed Dial
- Redial List
- Call List
- Corp. Directory
- My Directory
- Voicemail
- Paging Zones
- DND

Services Menu

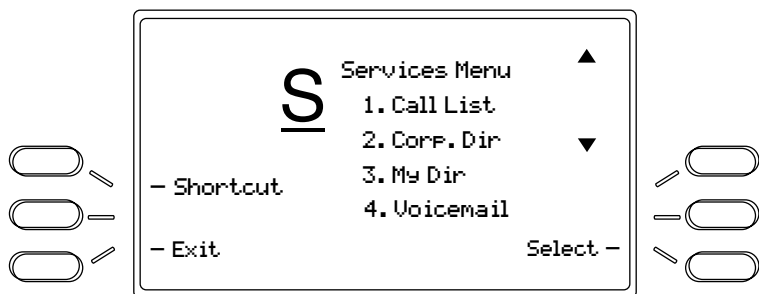

Services

The  *Services* key provides access to all available services. Use the display screen to view and access available services.

Administering Services

Most services have customizable options to allow you to personalize your phone to best meet your needs. The  key provides access to all customizable options. You can choose to protect your options with a password, if desired. Use the display screen to view and access the options. See the specific procedures in this guide for detailed information about how to customize each option.

Stored Number Lists

There are two temporary stored lists of caller information available on the VentureIP 480i telephone. The callers list contains a listing of up to 100 names and numbers of your most recent incoming callers.* The redial list contains a listing of up to 100 of your most recent outgoing caller records. Both lists are automatically updated with each incoming or outgoing call.

You can use the entries in these lists to quickly dial outgoing calls.

Because these lists are temporary, you cannot modify the entries in these lists. You can, however, copy the information contained in these lists to one of the permanent lists for permanent storage.

The permanent stored number lists (Directories and Speed Dial Lists) contain permanent records of contacts or phone numbers. You can use the entries in these lists to quickly dial outgoing calls, or to view detailed contact information.

There are two Directories: Corporate and Personal.

The Corporate Directory is automatically maintained by the phone system and contains up-to-date contact information about every person connected to your phone system. You can only modify your own information in the Corporate Directory.

Your Personal Directory is populated and maintained by you. Use the Personal Directory to maintain up-to-date information about phone contacts that are not within your company.

The Speed Dial List is populated and maintained by you. Use the Speed Dial List to store frequently dialed numbers.

*Availability of feature dependant upon subscription to services offered by your phone system or service provider

Changing Your Personal Information

Last Name

You can set the name that is associated with your telephone. Your name is automatically entered in the Corporate Directory. Your name is also used by the Auto Attendant's dial-by-name feature when callers enter your last name to reach you.

Changing Your Last Name

1. Press the **▲** key.
2. If your user options password is enabled, enter your password and press **Done**.
3. Navigate to the Last Name list item and press **Select**.
4. Press **Change** and enter the new name. See “**Entering Letters and Characters**” for more information.
5. Press **Done**.

Passwords

You can change, enable, and disable the password for your user options. Enabling your password prevents anyone else from viewing or altering your personal options.

Changing Your Password

1. Press the **▲** key.
2. If your user options password is enabled, enter your password and press **Done**.
3. Navigate to the Password list item and press **Select**.
4. With the cursor on the **Change Pswd** list item, press **Select**.
5. Enter the new password and press **Next**.
6. Re-enter the password and press **Done**.

Enabling and Disabling Your Password

1. Press the **Options** key.
2. If your user options password is enabled, enter your password and press **Done**.
3. Navigate to the Password list item and press **Select**.
4. Navigate to the **Turn Pswd ON/OFF** list item and press **Select**.
5. Press **Yes** to confirm.

Customizing Your Phone

Language Selection

You can use the Language selection feature to set your preferred language on the display screen. Currently English and French languages are provided.

1. Press the  key.
2. If your user options password is enabled, enter your password and press **Done**.
3. Navigate to the Language list item and press **Select**.
4. With the cursor on **English** or **Français**, press **Select**.
5. Press **Ok** then **Exit**.

Note: See “Using Voicemail” to set the language for the voicemail instructions callers will hear.

Adjusting the Volume



Pressing the volume button adjusts the receiver, headset, speaker, and ringer volume.



- To adjust the ringer volume, leave the handset in the cradle and press the volume bar  while there is no active call.
- To adjust the handset volume, lift the handset and press the volume button while you are on a call. The handset will return to the default volume after you hang up from your call(s).
- To adjust the headset volume, press the volume button while on a call. The headset will return to the default volume after you hang up from your call(s).

Note: The default handset and headset volume is always set at medium.

- To adjust the speaker volume, press the volume button while the speaker is activated (activate the speaker by pressing .

Select Audio Path

You can use the Set Audio feature to indicate your preference on the audio path when you answer an incoming call by pressing a line key or the speaker /  button. The options are Handsfree, Handset and Headset.

1. Press the  key.
2. If your user options password is enabled, enter your password and press **Done**.
3. Navigate to the **Set Audio** list item and press **Select**.
4. Press **Headset**, **Hset/Spkr**, **Spkr/Hset** or **Handsfree**. When you select **Hset/Spkr** or **Spkr/Hset**, you can toggle between handset and speaker by pressing the speaker button .
5. Press **Exit**.

Self Test and Diagnostics

You can perform various hardware and software tests on the telephone set.

1. Press the  key.
2. If your user options password is enabled, enter your password and press **Done**.
3. Navigate to the **Diagnostic** list item and press **Select**.
4. With the cursor on **Basic Test** or **Advanced Test**, press **Select**. Follow the instructions on the screen if you select Advanced Test.

Making and Receiving Calls

Handsfree Calling

The Handsfree feature allows you to speak to someone without using the handset. To dial using Handsfree, press /☎ and then enter a number. To answer using Handsfree, press /☎ when a call is ringing.

To switch between Handsfree and the handset when the handset is off hook, press /☎. When the handset is on hook, press /☎ to disconnect a Handsfree call. When Handsfree is on, the speaker light turns on. When the speaker light is on, press at any time to mute Handsfree. The speaker light will flash and you will hear the caller, but they will not hear you. To switch between Handsfree and mute press .

Note: Handsfree operation as described above will be affected and may be disabled if the set audio option has been activated. See the section “**Customizing your phone**” for more information.

Make Calls Using a Stored Number List



You can use entries in any of the stored number lists to make a call.

Redialing a Recently Called Number

1. Press the **R** key. *The Outgoing Call List is shown on the display screen.*
2. Use the keys to move from one entry to the next.
3. If the number must be edited before using (for example, if a local call includes an area code), press **Edit#** and edit the number.
4. With the desired entry shown on the display screen:
 - For handset operation, lift the handset.
 - For Handsfree operation, press the /☎ key.

The selected number is dialed.

Making a Call Using an Incoming Call, Directory, or Speed Dial List

1. Press the  *Services* key. *The list of services is shown on the display screen.*
2. Using the   keys:
 - View the list of incoming (received) calls, navigate to the Call List item.



OR

 - View entries in the Corporate Directory or your Personal Directory, navigate to the appropriate list item.

OR

 - To view your Speed Dial list, navigate to the **Speed Dial** list item.
3. Press **Select**.

You can also access the Speed Dial list by pressing the **Speed Dial** softkey. The list (Call List or Speed Dial) or the first entry (Corporate and Personal Directory) is shown on the display screen.

4. Use the   keys to navigate to the desired number or entry.
5. When the cursor is beside the desired list number, or the desired Directory entry is shown on the display screen, press **Dial**.

The call is dialed using the selected number.



Note: You may have to edit the number in order to dial successfully.
(i.e. Add "9" or an area code prefix)

Receive Calls

The display screen shows information about incoming calls, including the name and number of the calling party. *

There are two options for handling incoming calls. You can answer the call or ignore the call.

Receiving A Call

1. To answer an incoming call:
 - For handset operation, pick up the handset.
 - For handsfree operation, press **Answer**, the  /  key, or the  key indicated by the flashing status light.
2. Alternatively, to ignore the call, press **Ignore**.

The phone immediately stops ringing and the call is treated as an unanswered call.

Receiving Multiple Calls

If you receive another call while on an active call, the Call Appearance status light for the new call changes from unlit to a fast blink. For more information, see the procedures in the "Call Handling."



*Availability of feature dependant upon subscription to services offered by your phone system or service provider

Call Duration

You can view the elapsed time of an active call at any time by viewing the timer on the display screen.

End a Call

The method for ending a call depends on whether the phone is in handset or handsfree operation.

- For handset operation, hang up the handset.
- For handsfree operation, press  or press the  key.

Call Handling

Hold

You can put a call on hold to receive additional incoming calls, to add callers to a conference call, or to temporarily remove yourself from the call.

1. To put a call on hold:

- If you are handling one active call, press the  key.

The  light blinks and the display screen shows the held status of the call. You can replace the handset without losing the call.



- If you have an active call and want to dial another call, press a  key for an unoccupied line (status light unlit).

The first active call is automatically put on hold.

- If you have an active call and want to receive another call, press the  key for the incoming line (status light blinking).

The first active call is automatically put on hold.

2. To retrieve a held call:

- If in handset operation, pick up the handset or press the  key that corresponds to the held line (status light blinking).
- If in handsfree operation, press the Hold key, the OffHold softkey, or the  key that corresponds to the held line (status light blinking).

Any other active calls are automatically put on hold.

Conference Calls

You can manage conference calls with three participants.

There are two approaches to setting up a conference call:

- you can make a private call with each party, put the caller on hold, and then add them to the conference call, or
- you can add each party directly to the conference call.

You can drop one or both parties from the conference call. You can also put individual or both parties on hold during a conference call.

Each one of your conference participants can in turn add another participant to the conference call. However, we recommend that the total number of participants in a conference call not to exceed 5.

Adding Parties to a Conference Call

1. To make private calls with each party before adding them to the conference call, make the private calls and put the callers on hold.

OR

- To add a caller directly to the conference call, go to Step 2.

2. Press the  Conf key or the Conference softkey.

3. To add held callers, navigate to the desired caller in the list and press **Select**. Go to Step 4.

OR

- To dial a call to be added directly to the conference call, press **Enter#**.

OR

- To dial a call to be added directly to the conference call using a number stored in a directory, press **FromDir**.

4. To dial a number, enter the number and press **Dial**.

OR

- To dial a number stored in a directory, use the ◀ ▶ keys to move from one entry to the next. With the desired entry displayed, press **Dial**.

5. Once the private call is established, press **AddToConf** to add the caller to the conference call.

Putting Conference Callers On Hold and Off Hold

1. To put parties on hold during a conference call:

- To put all parties on hold, from the main conference call status screen, press **Hold**.

OR

- To put individual parties on hold, from the main conference call status screen, press **ViewParties**. Navigate to the desired party and press **Hold**.

2. To take parties off hold:

- To take all parties off hold, from the main conference call status screen, press **OffHold**.

OR

- To take individual parties off hold, from the main conference call status screen, press **Parties**. Navigate to the desired party and press **OffHold**.

Dropping Parties from a Conference Call

1. To drop parties from a conference call:

- To drop all parties, from the main conference call status screen, press **Goodbye**.

OR

- To drop individual parties, from the main conference call status screen, press **ViewParties**. Navigate to the desired party and press **Drop**.

Mute

You can prevent a caller from hearing you through the handset or handsfree microphone.

1. To activate mute while on a call, press the  key.

The display screen indicates your muted status.

2. Press the  key again to turn mute off.

Transfer

You can transfer an active call to any of the following:

- another dialed number
- another number contained in a Directory
- a Voicemail system

If you transfer a call to another number, you can choose to transfer the call directly, or you can consult with the party receiving the call before the transfer takes place.

Transferring a Call

1. Press the  *Xfer* key.

- To transfer the call to a dialed number, enter the number.

OR

- To transfer the call to a number stored in a Directory, press **FromDir**.

The default Directory is displayed.

OR

- To transfer the call to a Voicemail system, press **UMail**.

2. To transfer the call to a number stored in a Directory, navigate to the desired entry. If necessary, press **MyDir** to switch from the Corporate Directory to your Personal Directory.

3. To consult with the party receiving the transferred call prior to the transfer, press **Consult**.

OR

- To transfer the call directly with no consultation, press **Complete**.

Call Forwarding

Options for Forwarding Calls

You can forward all calls automatically, or you can forward all unanswered calls after a specified number of rings. You can forward calls to:

- a Voicemail system
- an internal (company) number
- an external number

Setting Up Call Forwarding

1. Press the **▲** key.
2. If your user options password is enabled, enter your password and press **Done**.
3. Navigate to the Call Forwarding option and select it.

You can also access the Call Forward Option list by pressing the **CallFwd** softkey.

4. To forward all calls automatically, select the **All Calls** option.
Go to Step 6.

OR

- To forward unanswered calls after a specified number of rings, select the **After X Rings** option.
5. Use the **◀ ▶** keys to increase or decrease the desired number of rings and press **Done**.
 6. Choose one of the following:
 - 1. Voicemail
 - 2. Directory #
 - 3. External #
 7. If you chose 2. **Directory #**:

- Scroll to the extension you want to forward your calls to.

OR

- Select **MyDir** and scroll to the number you want to.
8. If you chose 3. **External #**, use the keypad to enter the number you want to forward your calls to.

Using Voicemail

Menu

Zero Redirect

Record Name

Greeting

Language Selection

Voicemail Menu

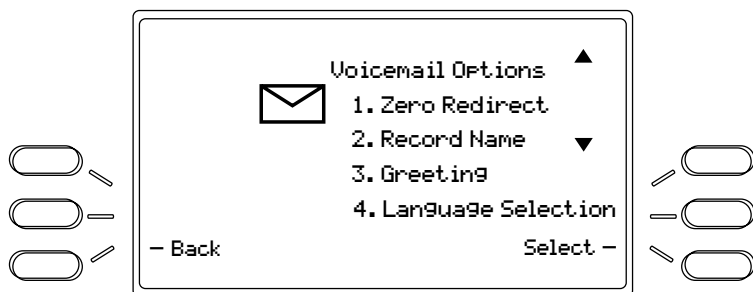

About Voicemail

Each VentureIP 480i stores up to twenty minutes of Voicemail messages.



It is recommended that you delete messages (using the **Delete** softkey button) regularly to ensure that callers can leave you a message. Callers will hear a busy tone if your Voicemail is full.

View, Play, and Monitor Incoming Voicemail Messages

You must log into your Voicemail system in order to perform any Voicemail functions. When a call is unanswered and the caller starts recording a Voicemail message, the display screen shows the number of the caller*, and indicates that they are recording their message. You can use this information to monitor incoming Voicemail messages.

*Availability of feature dependant upon subscription to services offered by your phone system or service provider

Logging In and Viewing Messages

1. Press the  *Services* key.
2. Navigate to the Voicemail list item, and then press **Select**.
You can also access your Voicemail list by pressing the **Voicemail** softkey.
3. Using the dialpad, enter your password.
4. Press **Done**.
5. Use the   keys to move from one message to the next.

Playing a Message

1. With the desired Voicemail message entry shown on the display screen, press **Play**.
2. To pause the playback, press **Pause**. Press **Resume** to resume playback.
3. To skip forward or backward by three seconds, press the appropriate **Skip** softkey.

Monitoring Incoming Voicemail Message

1. When the display screen is showing that a caller is recording a voicemail message:
 - To listen to the message as it is being recorded, press **Listen**.
You can hear the caller's message as it is being recorded without the caller's knowledge.
 - To ignore the Voicemail message and return to an idle display screen, press **Ignore**.
 - To retrieve the caller from Voicemail, press **Pickup**.

You are connected to the caller.

Manage Voicemail Messages

Once you have viewed and played your Voicemail messages, you have several options.* You can copy the contact information from the message into your Personal Directory or Speed Dial list. You can return the message, provided that you have entered your email address into your Voicemail options (see “**Change Voicemail Options**”).

You must log into your Voicemail system in order to perform any Voicemail functions. See “**Logging In and Viewing Messages**” above to log in.

*Availability of feature dependant upon subscription to services offered by your phone system or service provider

Copying the Caller Information to your Directory or Speed Dial List

1. With the desired Voicemail entry shown on the display screen, press **Copy**.
2. Navigate to the desired copying location and press **Select**.
3. To add the contact information to your Personal Directory, if necessary, enter the contact name (see “**Entering Letters and Characters**”) and press **Done**. (This step is necessary only if the entry did not contain a name.) Press **OK**.

OR

- To add the contact to your Speed Dial list, navigate to an empty Speed Dial list item, or to an occupied list item that you want to replace with the new entry. Press **Assign** (for an empty list item) or **Replace** (for an occupied list item).

The name (if available) or number (if no name is available) is assigned to the selected list item.

Zero Redirect

This allows the caller to press 0 (zero) to be transferred to another extension or to an external telephone number (for instance your mobile phone). Please note that the caller will have to press 0 during your greeting.

1. Press the **▲** key.
2. If your user options password is enabled, enter your password and press **Done**.
3. Navigate to Voicemail.
4. Navigate to the Zero Redirect and press **Select**.
5. Press **Change**.
6. Enter an extension number or an external telephone number (including the prefix 9) that you wish callers to be transferred to.
7. Press **Done**.
8. You can active or deactivate Zero Redirect by pressing **TurnOff** or **TurnOn**.

Language Selection

Following the voice mail greeting, the callers will hear short prompts guiding them to use the system. You can set the language for these prompts to English or French. English language is used by default. To change the language:

1. Follow the steps to login to voice mail
2. Press **Language**

Navigate to the desired language and press **Select**.

Change Voicemail Options

You can record and change your name and greeting.

Recording Your Name and Greeting

1. Press the **▲** key.
2. If your user options password is enabled, enter your password and press **Done**.
3. Navigate to **Voicemail**.
4. Navigate to the **Record Name** list item and press **Select**.
5. Press **Record** and record your name. Press **Stop** when finished.
6. To listen to your recording, press **Playback**. If necessary, press **ReRecord** and record your name again.
7. Once you have successfully recorded your name, press **Done**.
8. Navigate to the **Greeting** list item and press **Select**.
9. Press **Record** and record your greeting. Press **Stop** when finished.
10. To listen to your recording, press **Playback**. If necessary, press **ReRecord** and record your greeting again.
11. Once you have successfully recorded your greeting, press **Done**.

Retrieving Voicemail

Voicemail messages can be retrieved from any telephone set.

To access messages:

1. Dial the extension of the mailbox you want to access.
2. Press the * to enter Voicemail. Please note that * must be entered while the greeting is being played.
3. Enter the User Password followed by #
(the default user password is 1-2-3-4-5)
4. Follow the prompts to listen and delete messages.
5. To exit, hang up or press *.

Message Review Options

The following keys can be used when reviewing messages:

1	rewind 3 seconds
2	toggle between Pause and Play
3	fast forward 3 seconds
4	return to the beginning of the message
5	envelope information
7	erase message
8	reply to message
9	save message
#	skip message

Callers

When callers reach a mailbox they can review or delete their message before they commit it to the mailbox. The following keys can be used:

#	break from recording
1	store message
2	review message
3	erase and re-record
4	append more information to message
*	exit without leaving message

Using Directories

About Directory Lists

Directory lists contain stored contact information. You can quickly dial calls using directory entries. For information about making calls using a directory listing, see “**Making a Call Using an Incoming Call, Directory, or Speed Dial List.**”

There are two types of Directory lists:

Corporate Directory — this directory is automatically populated and updated, and contains all of the contact information for each person in your company. You cannot add to, edit, or delete entries in this directory.

Personal Directory — this directory is populated and maintained by you. You can add, edit, and delete entries in this directory.

Access and View a Directory List

You can quickly access and view directory entries using various methods.

Accessing a Directory List and Viewing the Entries

1. Press the  *Services* key.

2. To access the Corporate Directory, navigate to the **Corp. Directory** list item and press **Select**.

OR

- To access your Personal Directory, navigate to the **My Directory** list item and press **Select**.

You can also access the Directories by pressing the **Directory** softkey.

The directory main page shows the directory name and number of entries.

3. To navigate the entries:

- Use the   keys to move from one entry to the next.

OR

- Using the dialpad, spell the name associated with the desired entry.

The entry is displayed when a unique match is found.

4. To switch directories, press **MyDir** (from the Corporate Directory), or **CorpDir** (from your Personal Directory).

Change Directory Displays

You can change your default directory (initially the Corporate Directory), and you can change the way that directory entries are sorted.

Changing the Default Directory

1. Press the  key.

2. If your user options password is enabled, enter your password and press **Done**.

3. Navigate to Directory and press **Select**.

4. With the cursor on the **Default Dir** list item, press **Select**.

5. Navigate to the desired directory and press **Select**.

Add, Delete, and Edit Entries

You can add, delete, and edit entries in your Personal Directory only.

Adding Entries Manually

1. Access your Personal Directory.
2. From the main directory page, press **AddNew**.
3. Using the dialpad, enter the name for the new entry (see “**Entering Letters and Characters**”) and press **Next**.
4. Enter the number for the new entry.
5. Press **Done**.

Adding an Entry From the Caller List or a Voicemail Message

You can copy entries from the Incoming Call List *, or you can copy the contact information associated with a Voicemail message in order to permanently store the information in your Personal Directory.

To copy a call list entry into your Personal Directory, see “**Copying an Entry from a Call List**.”

To copy the contact information from a Voicemail message into your Personal Directory, see “**Copying Caller Information to your Directory or Speed Dial List**.”

Deleting One Entry

1. Access your Personal Directory and navigate to the entry to be deleted.
2. Press **Delete**.
3. Press **Yes** to confirm the deletion.

Editing an Entry

4. Access your Personal Directory and navigate to the desired entry.
5. Press **Edit**.
6. If desired, edit the name, and then press **Next**.
7. If desired, edit the number, and then press **Done**.

*Availability of feature dependant upon subscription to services offered by your phone system or service provider

Using a Call List

About Call Lists

There are two call lists:

- **Redial Call List** — contains a record of dialed numbers.
- **Incoming Call List** — contains a record of received calls, regardless of whether the calls were answered.*

The call lists contain temporary entries. When the lists are full, the most recent call is added and the oldest call is deleted.

You can use call list entries to quickly dial out calls. See “**Redialing a Recently Called Number, or Making a Call Using an Incoming Call List, a Directory List, or a Speed Dial List.**” You cannot save any changes to call list entries.

Access and View a Call List

You can quickly access and view call list entries using various methods.

Accessing a Call List and Viewing the Entries

1. Press the  *Services* key.
2. To access the incoming call list, navigate to the **CallList** item and press **Select**.



You can also access the Call list by pressing the **CallList** soft key.

The main call list page shows the number of missed calls.

OR

- To access the outgoing call list, navigate to the **Redial List** item and press **Select**.

The first entry in the list is shown.

3. To set the missed call counter back to “0”, press **ClearList**.
4. Use the   keys to move from one entry to the next.

The outgoing call list entries show the date and time the call was made.

The incoming call list entries show the date the time the call was made, regardless of whether the call was answered, and whether or not the entry has been previously viewed.

Edit Entries

You can temporarily edit an entry for immediate use, but you cannot save the changes. If you want a permanent record of the entry (which can be edited and saved), see “**Add a Call List Entry to a Personal Directory or Speed Dial List below.**”

Temporarily Editing a Call List

1. Access the call list and navigate to the desired entry.
2. Press **Edit#**.
3. Edit the number, and then press **Done**.

*Availability of feature dependant upon subscription to services offered by your phone system or service provider

Add a Call List Entry to a Personal Directory or Speed Dial List

If you want a permanent record of a call list entry, you must copy the entry to either your Personal Directory, or your Speed Dial list.

Copying an Entry from a Call List

1. Access the call list and navigate to the desired entry.
2. Press **COPY**.
3. Navigate to the desired copying location and press **Select**.
4. To add the entry to your Personal Directory, if necessary, enter the contact name, (see “**Entering Letters and Characters**”) and press **Done**. (This step is necessary only if the entry did not contain a name.) Press **OK**.

OR

- To add the entry to your Speed Dial list, navigate to an empty Speed Dial list item, or to an occupied list item that you want to replace with the new entry. Press **Assign** (for an empty list item) or **Replace** (for an occupied list item).

The name (if available) or number (if no name is available) is assigned to the selected list item.

Delete Call List Entries

You can delete individual call list entries, or you clear a list of all entries.

Deleting an Entry

1. Access the call list and navigate to the desired entry.
2. Press **Delete**.

Deleting All Entries

1. Press the **▲** key.
2. If your user options password is enabled, enter your password and press **Done**.
3. Navigate to the Call List item and press **Select**.
4. To clear the incoming call list, navigate to the **Clear Incoming** list item and press **Select**.

OR

- To clear the outgoing call list, navigate to the **Clear Dialed** list item and press **Select**.
 - To clear both lists, navigate to the **Clear All** list item and press **Select**.
5. Press **Yes** to confirm.

Using Speed Dial

About Speed Dial

The Speed Dial list allows you to store frequently called numbers for instant dialing. For information about making calls using Speed Dial, see “**Making a Call Using a Speed Dial Number or Making a Call Using an Incoming Call, Directory, or Speed Dial List.**”

Access and View the Speed Dial List

If you cannot remember a Speed Dial number assignment, or if you want to administer your Speed Dial list, you can quickly access and view your Speed Dial list entries.

Accessing the Speed Dial List and Viewing the Entries

1. Press the  *Services* key.

2. Navigate to the **SpeedDial** list item and press **Select**.

You can also access the Speed Dial list by pressing the **SpeedDial** soft key.

3. Use the   keys to move from one entry to the next.

Add and Edit Entries

You can add new entries to your **Speed Dial** list manually, or by copying a Call List or Voicemail entry. You can also edit existing entries.

Adding Entries Manually

1. Access the **Speed Dial** list and press **AddNew**.

2. If desired, use the dialpad to enter the name for the new entry and press **Next**.

3. Enter the number for the entry.

4. Press **Done**.

5. Navigate to an empty Speed Dial list item, or to an occupied list item that you want to replace with the new entry. Press **Assign** (for an empty list item) or **Replace** (for an occupied list item).

Adding Entries From a Caller List or Voicemail Message

You can copy entries from the Incoming Call List, or you can copy the contact information associated with a Voicemail message to your Speed Dial list.

To copy a call list entry into your Speed Dial list, see “**Copying an Entry from a Call List.**”

To copy the contact information from a Voicemail message into your Speed Dial list, see “**Copying the Copying the Caller Information to your Directory or Speed Dial List.**”

Editing Entries

1. Access your Speed Dial list and navigate to the desired entry.
2. Press **Edit**.
3. If desired, edit the name, and then press **Next**.
4. If desired, edit the number, and then press **Done**.
5. If you want to change the key assignment, press **Yes** in answer to the prompt and go to step 6.
OR
 - If you don't want to change the key assignment, press **No** in answer to the prompt. You have completed this procedure.
6. Navigate to an empty Speed Dial list item, or to an occupied list item that you want to replace with the new entry. Press **Assign** (for an empty list item) or **Replace** (for an occupied list item).

Special Features

Do Not Disturb

You can use the Do Not Disturb feature to prevent your phone from ringing for incoming calls, and to prevent your phone from broadcasting pages.

Note: Incoming calls will be sent directly to voicemail.

Enabling and Disabling the Do Not Disturb Feature

1. Press the  *Services* key.
2. Navigate to the **DND** list item and press **Select**.

You can also access the DND list item by pressing the **DND** soft key.

3. To enable the feature, press **TurnON**.
4. To disable the feature, press **TurnOFF**.

Intercom

You can use the paging feature to broadcast a message to a pre-defined set of phones. All persons in the paging zone hear the broadcast, unless they are on an active call.

Your telephone administrator must have set up paging zones in order for you to use this feature.

Using the Intercom Feature

1. Press the  *Icom* key.
2. Navigate to the desired paging zone and press **Select**.
3. Speak into the handset or handsfree speaker.
4. When finished, press **Done**.

Computer Access to Telephone Features

You can use Microsoft Internet Explorer browser to access some features within your telephone. These features include:

- Within Home Page
 - Set your call forwarding options. See the section “**Call Forwarding**” for more information
 - Enable or disable Do Not Disturb. See the section on “**Special Features**” for more information
 - Enter numbers for speed dial keys. See the section on “**Using Speed Dial**” for more information
- Within Caller’s Log Page
 - View a list of your incoming calls
 - View a list of your outgoing calls
- Within Directory Settings Page
 - Change your default directory to Corporate or Personal directory
- Within Terminal Settings Page
 - Change the last name associated with your telephone

To use the browser to connect to your phone:

1. Determine the IP address for your telephone:
 - Press the  key.
 - If your user options password is enabled, enter your password and press **Done**.
 - Navigate to the Diagnostics list item and press **Select**.
 - With the cursor on Advanced Test, press **Select**. Follow the instructions on the screen to step 7
 - Note the IP address as displayed on the screen
2. Run Microsoft Internet Explorer.
3. On the address field enter `http://your-IP-address`
4. Enter your extension number and password

Troubleshooting

Why can't I add, edit or delete directory entries?

You cannot edit the Corporate Directory, which is automatically maintained by the 480IP system. If you are attempting to edit your Personal Directory, ensure that the directory is not locked.

Why aren't all the phones in a paging zone receiving pages?

Ensure that all phones are on-hook, and that the Do Not Disturb feature is disabled.

Why can't I edit my directory name?

Ensure that your telephone system administrator has allowed this option.

Why can't I forward Voicemail messages to my email?

You must define your email address using the Options key before you can forward messages to your email.

Why does my telephone wobble?

Ensure that the cords are routed properly through the stand. Check that the stand has been properly snapped into place.







Why is my display screen blank?

Ensure that power is being provided to your phone. If your Network does not provide Inline power over Ethernet, you can obtain an additional accessory (PoE inline power supply), to provide power over Ethernet locally to your phone. See **"Connect to the Network and to a Power Source"** for details.

Why is my handset not working?

Check to ensure that the handset cord is fully connected to both the phone and handset. See the section **"Installation"** for information.

Why is my speakerphone not working?

If you press / and the speaker light flashes and you do not hear dialtone, the **Set Audio** option has been used to set up the phone for headset use. Press / a second time. If the light goes out, the phone is set up to be used only with a headset or handset. If the light stays on steady and you hear dialtone, you can alternate between the speakerphone and the headset by pressing /. See the section **"Customizing your phone"** for instructions on how to change the **Set Audio** feature.

How do I remove the stand from the phone?

Place one hand on top of the phone, and place the other hand on the top of the stand. Pull the stand away from the telephone. You will have to pull quite forcefully, but this will not break the stand.

Why are Callers not identified on the display?

Caller ID[†] information usually arrives between the first and second ring. Let the telephone ring at least once before answering. Make sure you subscribe to Caller ID[†] services from your local telephone company.

Why can't I dial a number in the Callers List?

You must subscribe to a Caller ID[†] service for names and/or numbers to be recorded in the Callers List. If the number of the caller is unknown or private, you cannot return the call. Or, the number may require an area code. Press the **EditNum** softkey to edit the number, then press the **Dial** softkey.

[†] These services may have different names in your area, contact your local telephone company for details.

Limited Warranty

Aastra Telecom warrants this product against defects and malfunctions during a one (1) year period from the date of original purchase. If there is a defect or malfunction, Aastra Telecom shall, at its option, and as the exclusive remedy, either repair or replace the telephone set at no charge, if returned within the warranty period.

If replacement parts are used in making repairs, these parts may be refurbished, or may contain refurbished materials.

If it is necessary to replace the telephone set, it may be replaced with a refurbished telephone of the same design and color. If it should become necessary to repair or replace a defective or malfunctioning telephone set under this warranty, the provisions of this warranty shall apply to the repaired or replaced telephone set until the expiration of ninety (90) days from the date of pick up, or the date of shipment to you, of the repaired or replacement set, or until the end of the original warranty period, whichever is later. Proof of the original purchase date is to be provided with all telephone sets returned for warranty repairs.

Exclusions

Aastra Telecom does not warrant its telephone sets to be compatible with the equipment of any particular telephone company. This warranty does not extend to damage to products resulting from improper installation or operation, alteration, accident, neglect, abuse, misuse, fire or natural causes such as storms or floods, after the telephone is in your possession.

Aastra Telecom shall not be liable for any incidental or consequential damages, including, but not limited to, loss, damage or expense directly or indirectly arising from the customers use of or inability to use this telephone, either separately or in combination with other equipment. This paragraph, however, shall not apply to consequential damages for injury to the person in the case of telephones used or bought for use primarily for personal, family or household purposes.

This warranty sets forth the entire liability and obligations of Aastra Telecom with respect to breach of warranty, and the warranties set forth or limited herein are the sole warranties and are in lieu of all other warranties, expressed or implied, including warranties or fitness for particular purpose and merchantability.

Warranty Repair Services

Should the set fail during the warranty period;

In North America, please call 978-436-4111 for further information.

Outside North America, contact your sales representative for return instructions.

You will be responsible for shipping charges, if any. When you return this telephone for warranty service, you must present proof of purchase.

After Warranty Service

Aastra Telecom offers ongoing repair and support for this product. This service provides repair or replacement of your Aastra Telecom product, at Aastra Telecom's option, for a fixed charge. You are responsible for all shipping charges. For further information and shipping instructions;

In North America, contact our service information number: 978-436-4111.

Outside North America, contact your sales representative.

Note: Repairs to this product may be made only by the manufacturer and its authorized agents, or by others who are legally authorized. This restriction applies during and after the warranty period. Unauthorized repair will void the warranty.

A

- Access and View
 - a Call List 32
 - a Directory List 30
 - the Speed Dial List 34
- Accessing a
 - Call List and Viewing the Entries 32
 - Directory List and Viewing the Entries 30
- Accessing the
 - Speed Dial List and Viewing the Entries 34
- Adding
 - an Entry From the a Caller List Entry or Voicemail Message 31
 - Entries From a Caller List or Voicemail Message 34
 - Entries Manually 31, 34
 - Parties to a Conference Call 21

B

- Backlit Display 7

C

- Call
 - Duration 20
 - Forwarding 24
 - Handling 21
 - Hold 21
- Callers 29
- Changing
 - the Default Directory 30
 - Your Last Name 15
 - Your Password 15
 - Your Personal Information 15
- Computer Access to Telephone Features 36
- Conference Calls 21

Connecting

- the Handset 4
 - When Inline Power is Not Provided 4
 - When Inline Power is Provided 3
- Conf key 8, 21
 - Copying
 - an Entry from a Call List 33
 - the Call ID 26,34
 - Copying the Caller Information to your Directory or Speed Dial List 27
 - Customizing Your Phone 16

D

- Deleting
 - All Entries 33
 - an Entry 33
 - Call List Entries 33
 - One Entry 31
- Direct Network Connection 3
- Display
 - Icons 11
 - Screen 7, 9
- Do Not Disturb 36
- Dropping Parties from a Conference Call 22

E

- Editing
 - an Entry 31
 - text 10
 - Your Password 15
- End a Call 20
- Entering Letters and Characters 10

H

- Handset, Headset, and Handsfree Operation 12
- Handsfree calling 18
- Hold 21

I

- Inserting the Number Card 6
- Installation 2
- Installing
 - on a Desk 5
- Intercom 36

K

- Key Description 7, 8

L

- Language Selection 16, 27
- Last Name 15
- Logging In and Viewing Messages 26

M

- Making a Call
 - Using an Incoming Call List, a Directory List, or a Speed Dial List 19
- Making and Receiving Calls 18
- Manage Voicemail
- Messages 26
- Mute 22

O

- Optional Accessories (Not Included) 2
- Options for Forwarding Calls 24
- Options key
 - 8, 14-17, 24, 27-28, 30, 33, 37
- Overview 2

P

- Passwords 15
- Phone Parts 1
- Playing a Message 26

R

- Receive Calls 19
- Receiving
 - A Call 19
 - Multiple Calls 19
- Recording Your Name and Greeting 28
- Redial key 8, 11, 18
- Redialing a Recently Called Number 18

S

- Select Audio Path 16
- Self Test and Diagnostics 17
- Services 13,14
 - key
 - 8,14,19, 26, 30, 32, 34, 36
 - Menu 13
- Set Overview 9
- Shared Network Connection 5
- Softkeys 9
- Special Features 36
- Status Light 11
- Stored Number Lists 14

T

- Temporarily Editing a Call List 32
- Terminal Name 15
- Transfer 23
- Transferring a Call 23
- Troubleshooting 38

U

- User
 - Options 12
 - Options Menu 12
- Using
 - a Call List 32
 - Directories 30
 - Speed Dial 34
 - the Intercom Feature 36
 - Voicemail 25

V

View, Play, and Monitor

Incoming Voicemail

Messages 25

Voicemail

Menu 25

Monitoring Incoming 26

Retrieving 28

Options 28

Volume 16

Handset 16

Key 8, 16

Z

Zero Redirect 27

If you've read this owner's manual and consulted the Troubleshooting section and still have problems, please visit our website at www.aastra.com or call 978-436-4111 for technical assistance.

© Aastra Telecom Inc. 2005 41-0095-00 Rev 00